

SECTION A-A
16

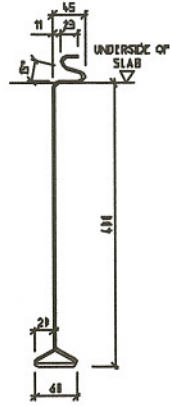

SECTION B-B
16

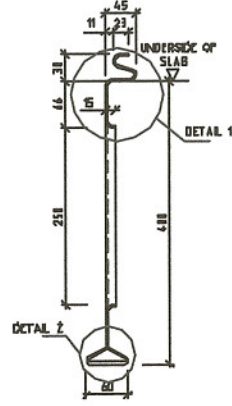

SECTION C-C
16

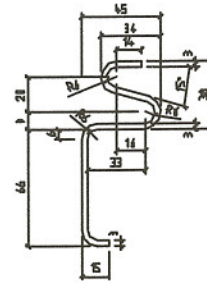

DETAIL 1

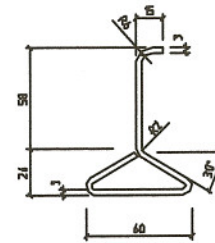

DETAIL 2

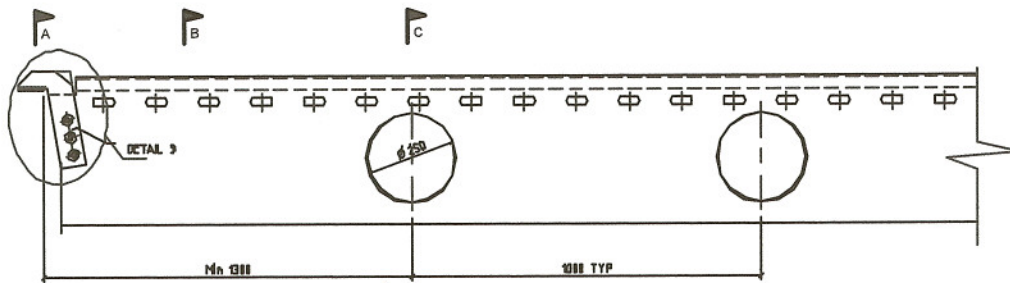

ELEVATION 400 SERIES
16

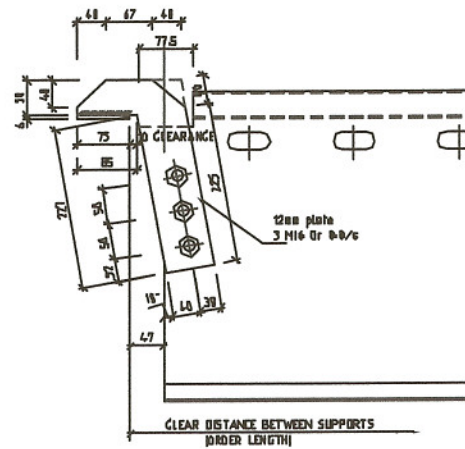

DETAIL 3
15

these drawings remain the property of Speedfloor Holdings Ltd and should not be copied in any form or passed on to a third party without prior written consent



© SPEEDFLOOR HOLDINGS LTD

PROJECT
SPEEDFLOOR JOISTS
400 SERIES

DRAWING TITLE
JOIST ELEVATION
AND DETAILS

DATE	SCALE
01/2025	AS SHOWN
DESIGNED	APPROVED
05	
DRAWN	CAD FILENAME
101	
ISSUING TEL.	S01 REV 1

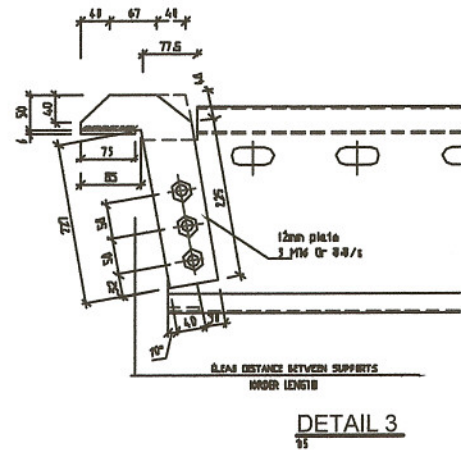
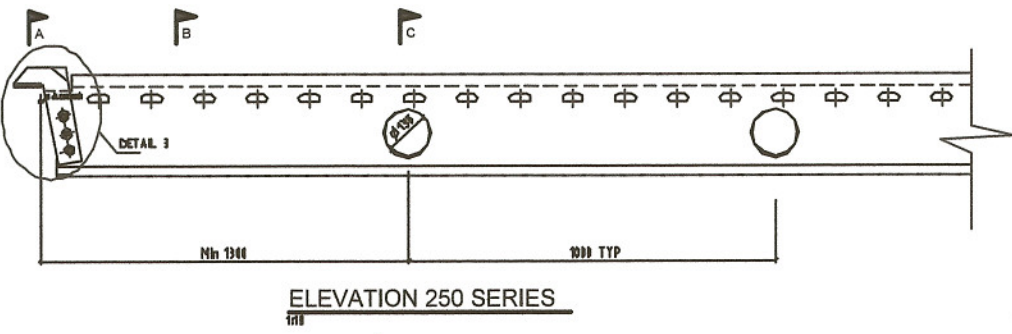
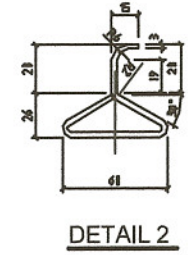
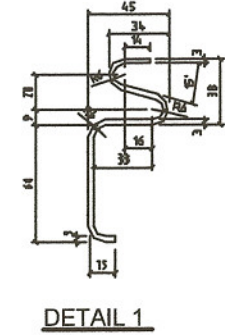
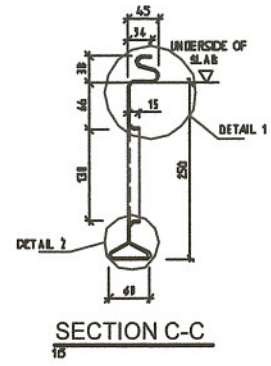
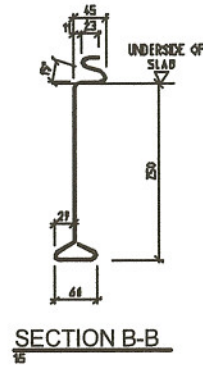
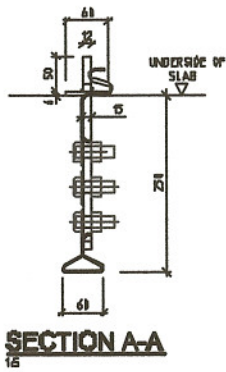

these drawings remain the property of Speedfloor Holdings Ltd and should not be copied in any form or passed on to a third party without prior written consent



SPEEDFLOOR HOLDINGS LTD

PROJECT
SPEEDFLOOR JOISTS
250 SERIES

DRAWING TITLE
JOIST ELEVATION
AND DETAILS

DATE	BY	CHKD	APPROVED
	08/03/05	AG	SKOVEN
DESIGNED	SA		
DRAWN	KN	CHKD	REVISIONS
DRAWING NO.	S02	REV	1

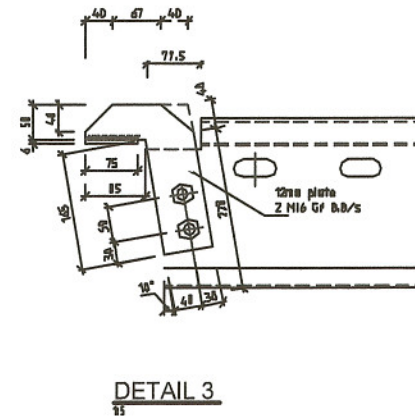
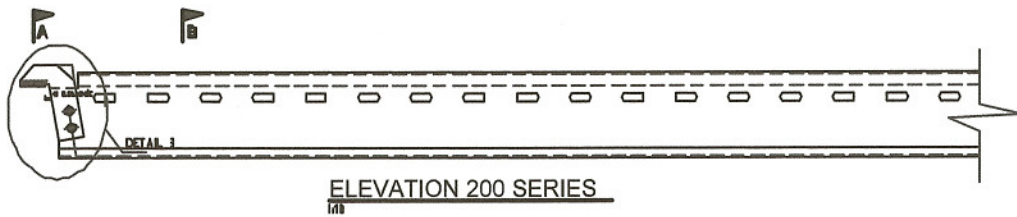
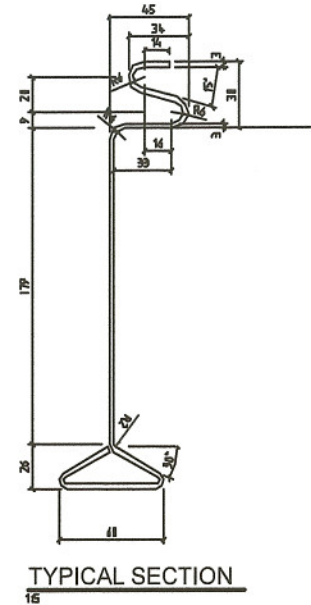
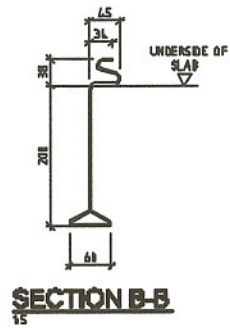
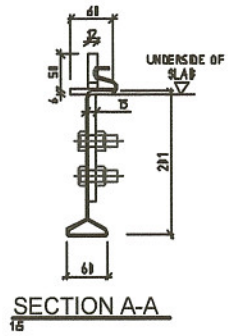

these drawings remain the property of Speedfloor Holdings Ltd and should not be copied in any form or passed on to a third party without prior written consent



SPEEDFLOOR HOLDINGS LTD	
PROJECT	
SPEEDFLOOR JOISTS 200 SERIES	
DRAWING TITLE	
JOIST ELEVATION AND DETAILS	
DATE	SCALE
02 JUN	AS SHOWN
DRAWN	APPROVED
NH	SHR ALEXANDER
DRAWING NO.	REV 1
S03	